

かつのうペントミノ 2D+3D解答

※複数解ある問題は 1 通りのみ、作成しております。御了承ください。

P4 基本問題・応用問題 共通解答

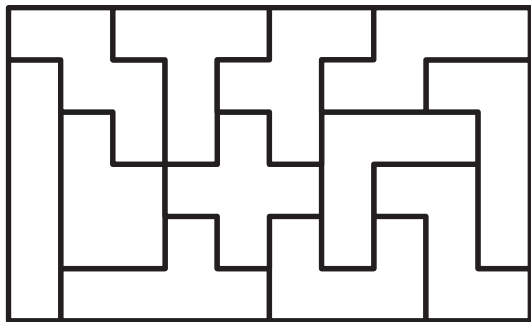

P6 基本問題・応用問題⑦ 共通解答

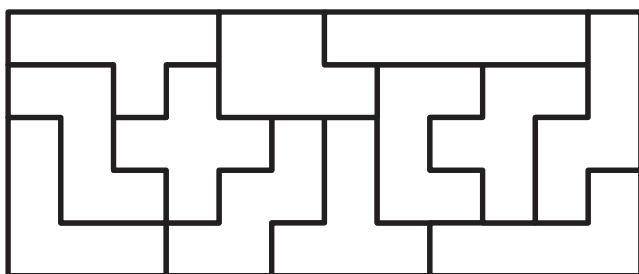

P6 応用問題

①F・I・L・P・W・Y

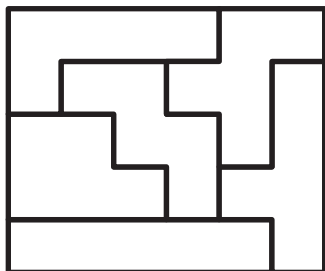

②U+①のピース

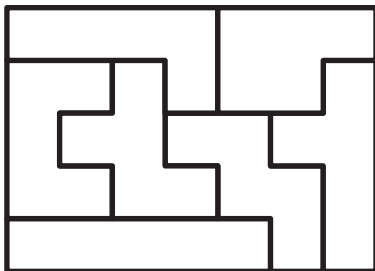

③T+②のピース

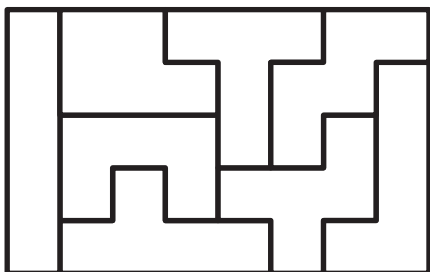

④N+③のピース

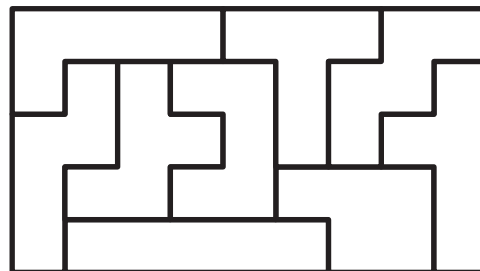

⑤Z+④のピース

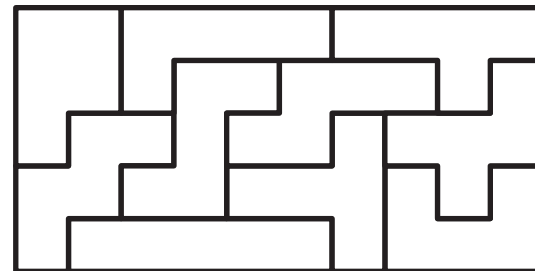

⑥X+⑤のピース

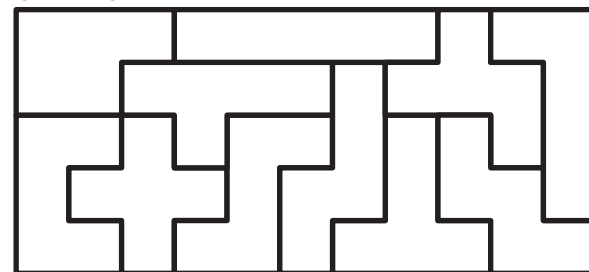

かつのうペントミノ 2D+3D 解答

※複数解ある問題は 1 通りのみ、作成しております。御了承ください。

P8 基本問題・応用問題 1 共通解答

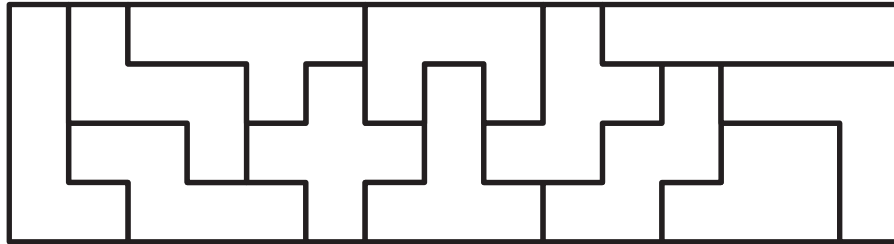

P8 応用問題 2

① F・L・T・Y

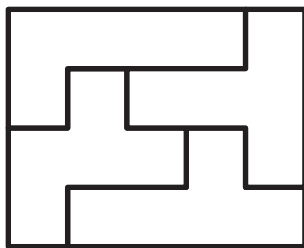

② F・L・P・U

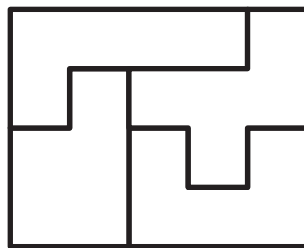

③ F・P・U・Y

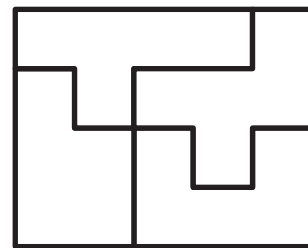

④ L・P・Y・Z

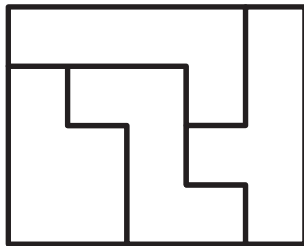

⑤ L・P・T・Y

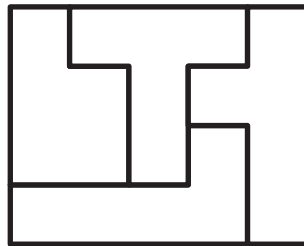

⑥ L・P・U・Y

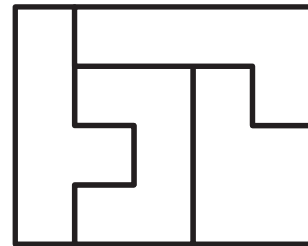

⑦ N・P・U・Y

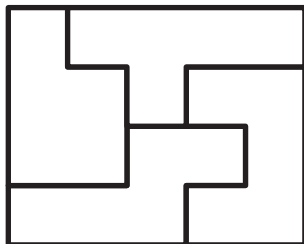

⑧ N・T・V・Y

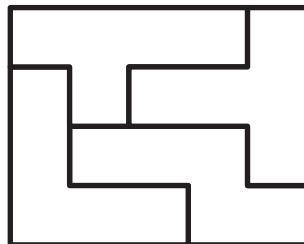

⑨ P・U・V・Z

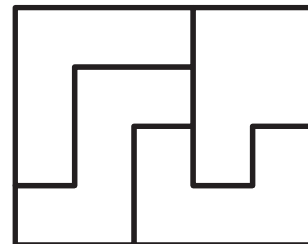

P10 基本問題

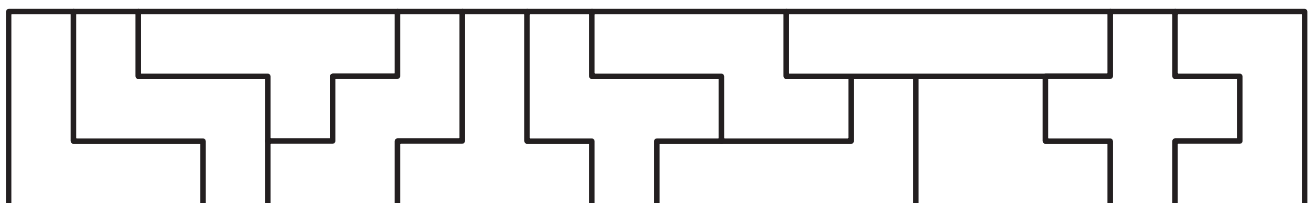

かつのうペントミノ 2D+3D 解答

※複数解ある問題は 1 通りのみ、作成しております。御了承ください。

P10 応用問題

① L・P・V

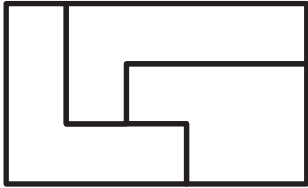

② L・N・V

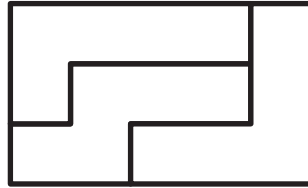

③ L・T・Y

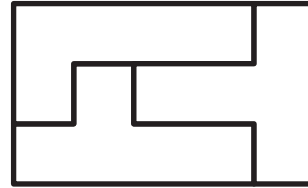

④ N・P・U

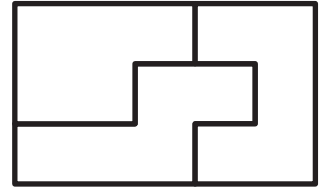

⑤ F・P・U

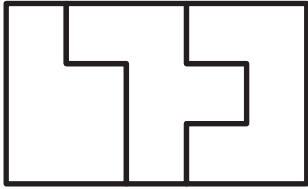

⑥ P・U・Y

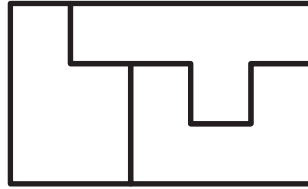

⑦ P・U・V

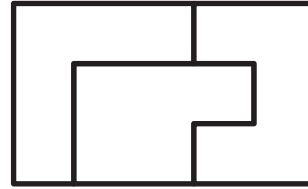

P12

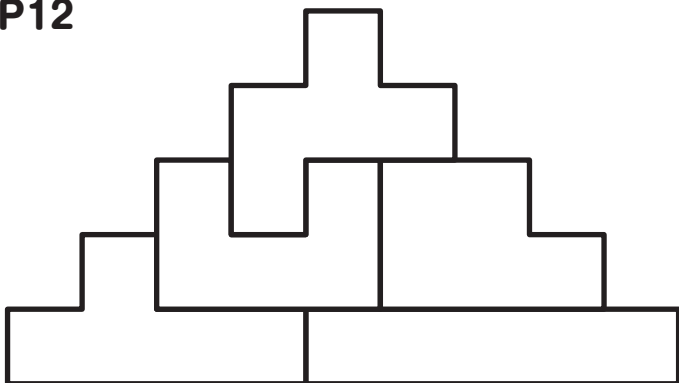

P13

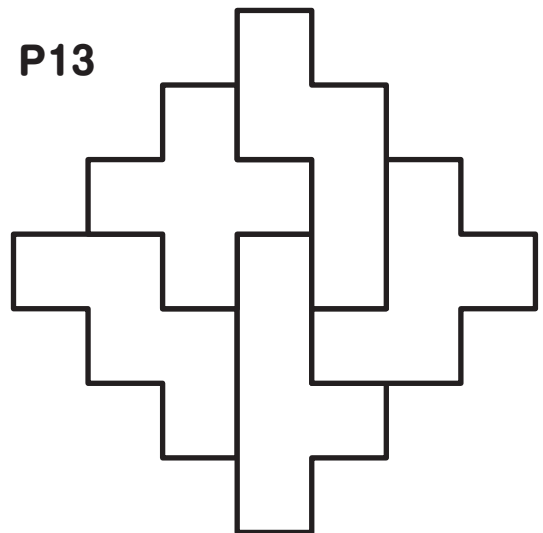

P14

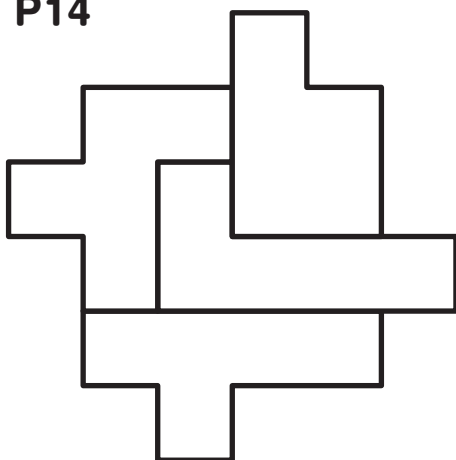

P15

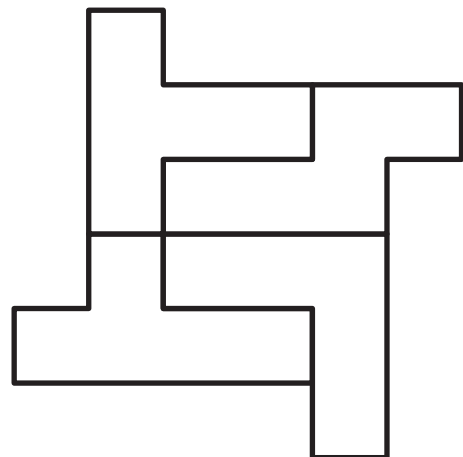

① F・L・U・Y

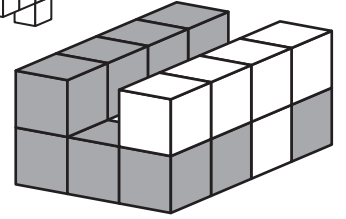
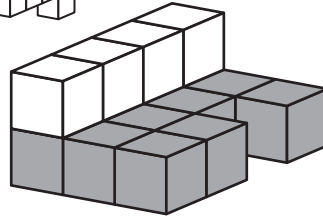
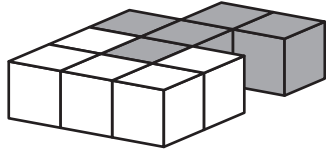
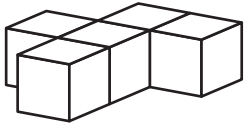

② L・P・W・Y

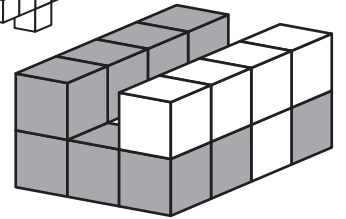
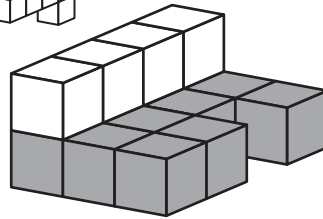
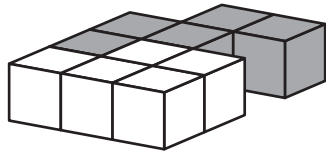
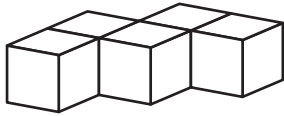
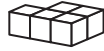
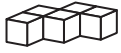

③ L・U・V・Y

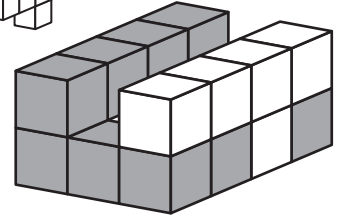
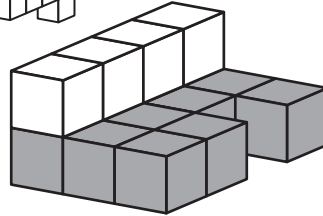
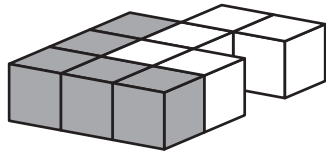
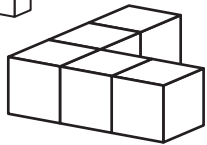

④ L・P・V・Y

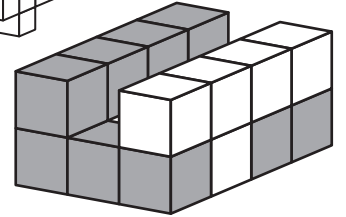
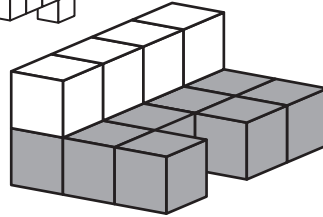
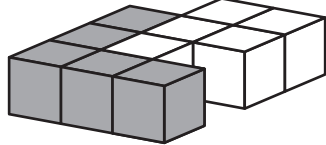
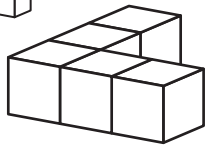

① N・P・T・Z

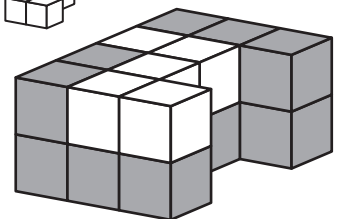
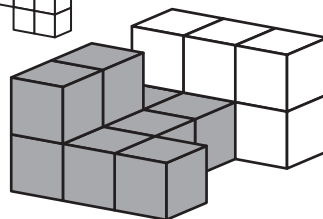
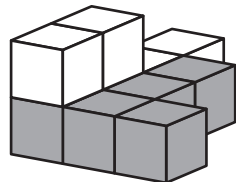
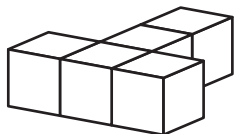

② L・P・U・Z

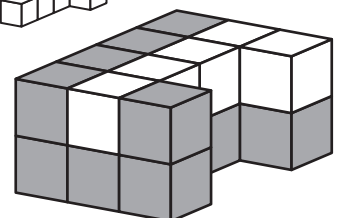
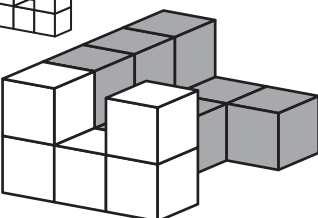
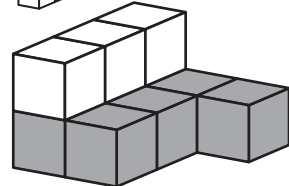
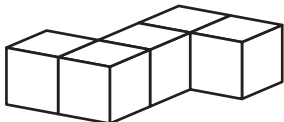
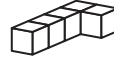
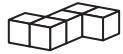

③ L・P・T・U

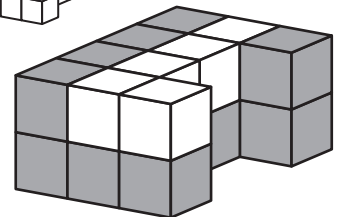
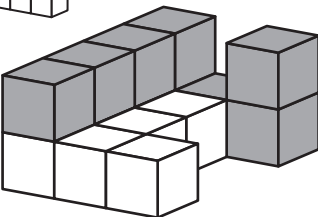
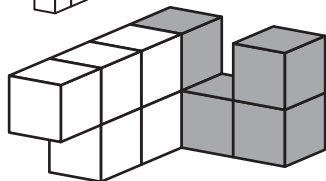
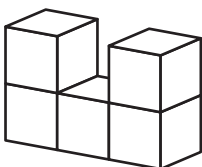

① F・L・N・Y

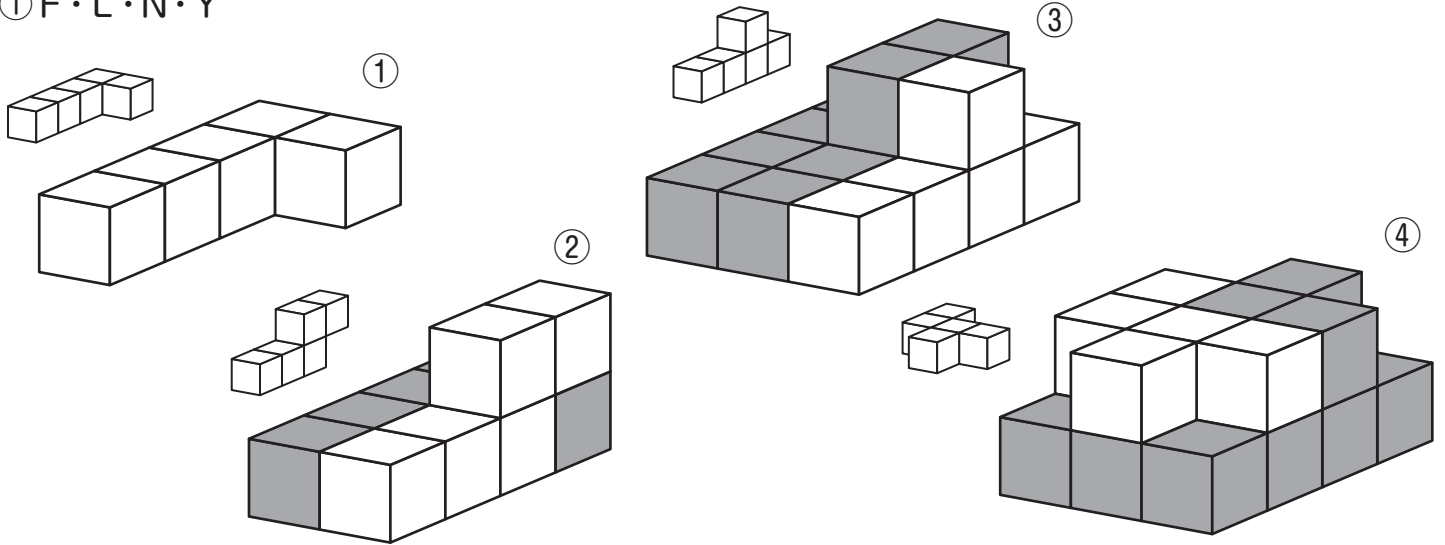

② F・L・P・Y

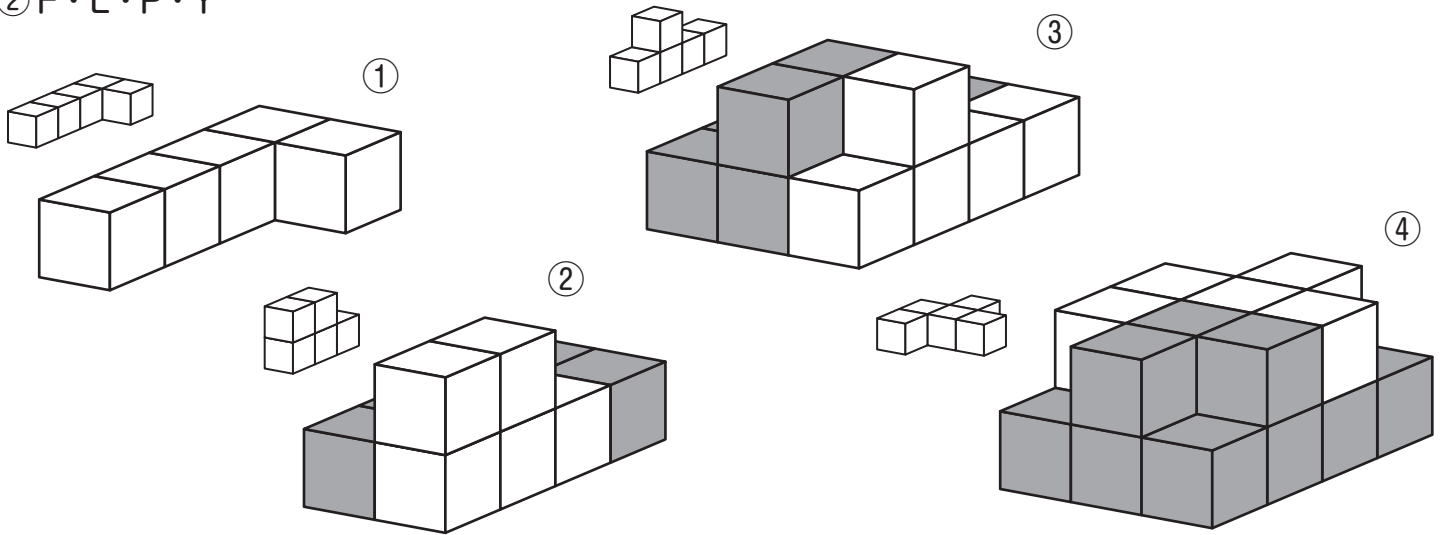

L・N・P・U・V・Y

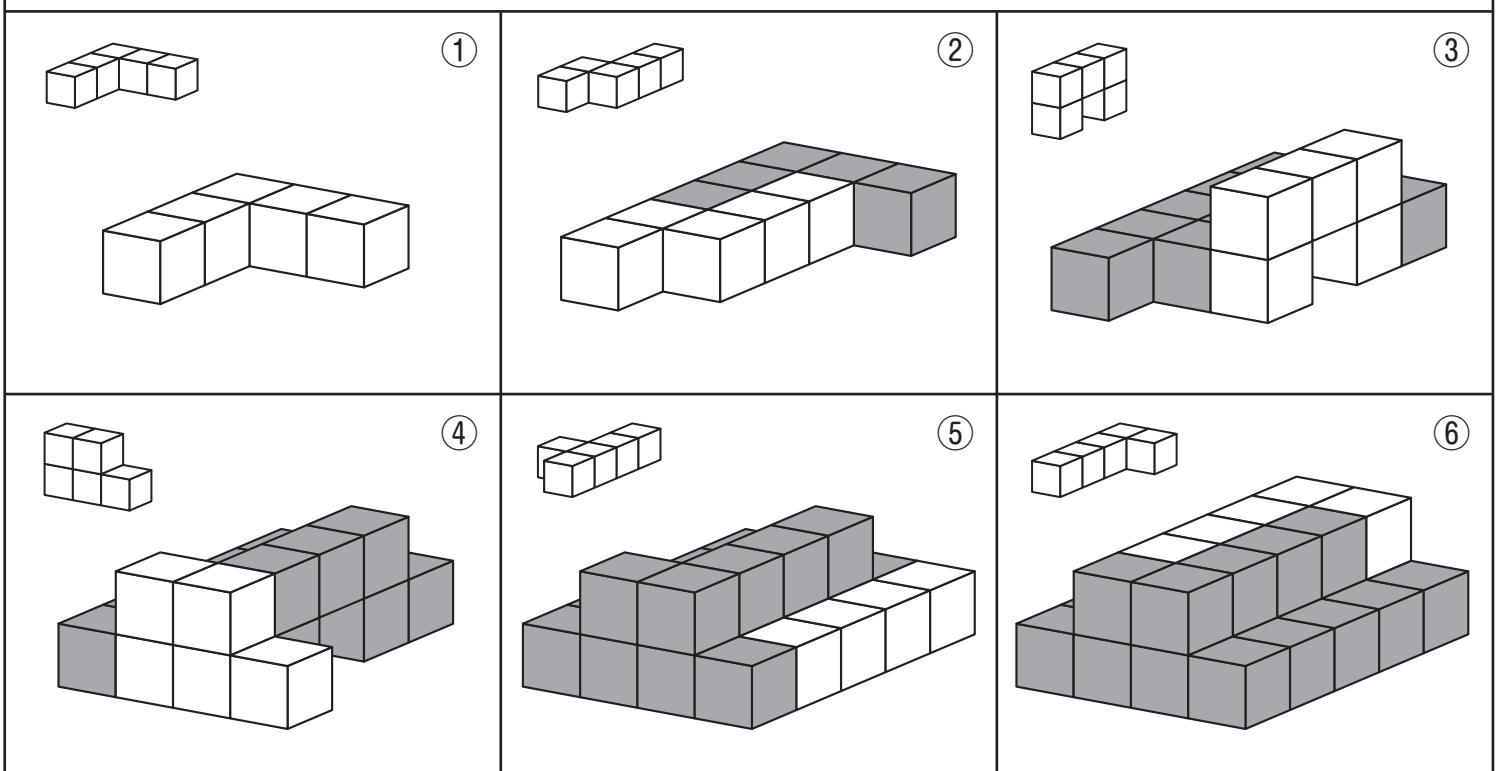

かつのうペントミノ 2D+3D 解答

※複数解ある問題は 1 通りのみ、作成しております。御了承ください。

① $3 \times 2 \times 10$ ※左上に使用するピースと、向きを記しています。

<p>①</p>	<p>②</p>	<p>③</p>	<p>④</p>
<p>⑤</p>	<p>⑥</p>	<p>⑦</p>	
<p>⑧</p>	<p>⑨</p>	<p>⑩</p>	
<p>⑪</p>	<p>⑫</p>	<p>完成</p>	

かつのうペントミノ 2D+3D 解答

P18

※複数解ある問題は 1 通りのみ、作成しております。御了承ください。

② $5 \times 2 \times 6$ ※左上に使用するピースと、向きを記しています。

<p>①</p>	<p>②</p>	<p>③</p>	<p>④</p>
<p>⑤</p>	<p>⑥</p>	<p>⑦</p>	
<p>⑧</p>	<p>⑨</p>	<p>⑩</p>	
<p>⑪</p>	<p>⑫</p>	<p>完成</p>	

かつのうペントミノ 2D+3D解答

※複数解ある問題は 1 通りのみ、作成しております。御了承ください。

③ $4 \times 3 \times 5$ ※左上に使用するピースと、向きを記しています。

<p>①</p>	<p>②</p>	<p>③</p>	<p>④</p>
<p>⑤</p>	<p>⑥</p>	<p>⑦</p>	
<p>⑧</p>	<p>⑨</p>	<p>⑩</p>	
<p>⑪</p>	<p>⑫</p>	<p>完成</p>	

かつのうペントミノ 2D+3D解答

P19

※複数解ある問題は1通りのみ、作成しております。御了承ください。

④4列5段階

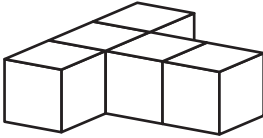
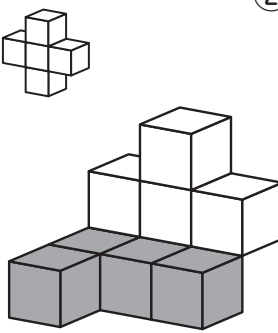
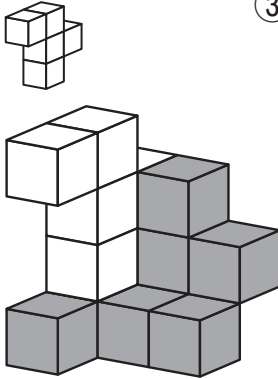
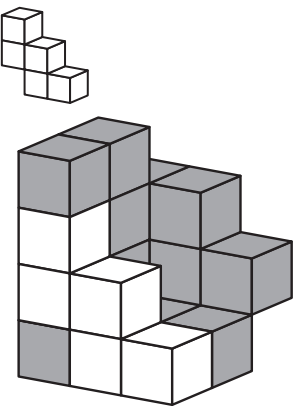
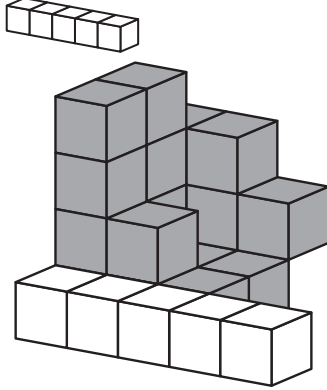
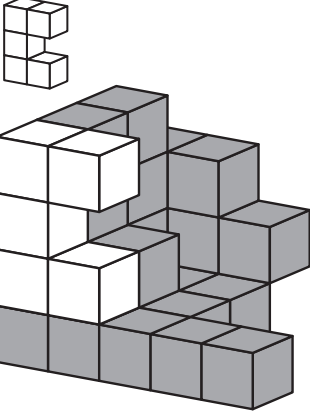
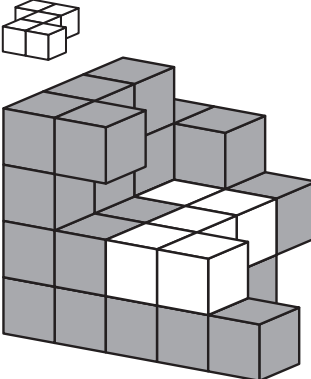
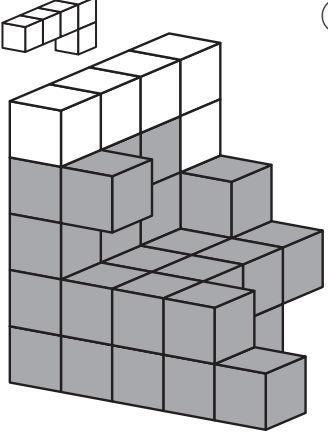
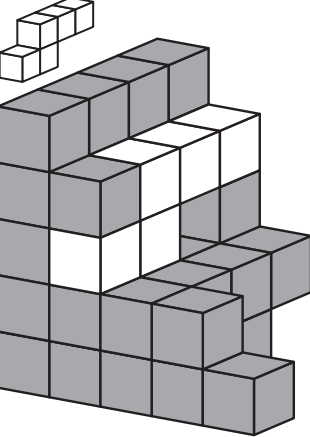
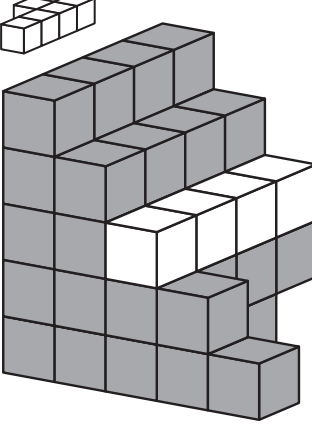
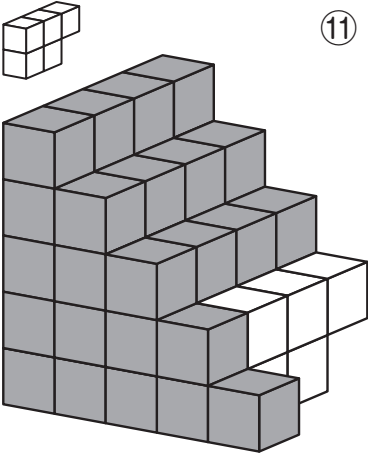
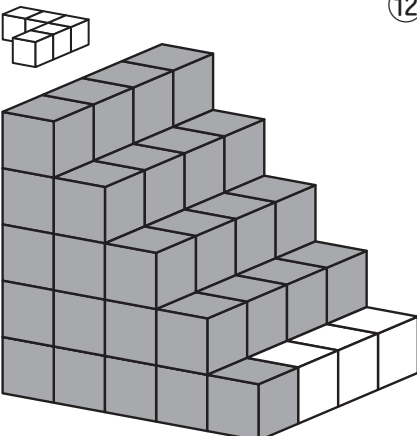
<p>①</p> 	<p>②</p> 	<p>③</p> 	<p>④</p> 
<p>⑤</p> 	<p>⑥</p> 	<p>⑦</p> 	
<p>⑧</p> 	<p>⑨</p> 	<p>⑩</p> 	
<p>⑪</p> 	<p>⑫</p> 	<p>完成</p> 